

TABLE OF CONTENTS

INTRODUCTION . . . . .	ii
LIST OF ILLUSTRATIONS . . . . .	iv
SITE SELECTION . . . . .	1
Drainage . . . . .	1
Accessibility . . . . .	1
Utilities . . . . .	1
Draft . . . . .	2
Space . . . . .	2
Other factors . . . . .	3
SANITATION . . . . .	3
SIZING THE SUGARHOUSE . . . . .	3
Basic house . . . . .	4
Fuel storage . . . . .	4
Sap storage tanks . . . . .	6
Syrup processing room (Sugar kitchen) . . . . .	8
Auxiliary storage . . . . .	9
DESIGN AND CONSTRUCTION . . . . .	9
Orientation . . . . .	9
Construction . . . . .	9
Foundation . . . . .	10
Floors . . . . .	10
Arch foundation . . . . .	10
Drains . . . . .	11
Walls . . . . .	11
Roof . . . . .	11
Ventilators . . . . .	11
Stacks . . . . .	12
Lighting . . . . .	12
Entrances . . . . .	13
Maintenance . . . . .	13
Expansion . . . . .	13
SUGARMAKER'S RATING SHEET . . . . .	14
SELECTED REFERENCES . . . . .	14
APPENDIXES . . . . .	15
A. Vermont Sugarhouse . . . . .	15
B. Cornell Sugarhouse . . . . .	17
C. 16 x 24 Sugarhouse . . . . .	21

LIST OF ILLUSTRATIONS

Table

1. Recommended Sugarhouse Dimensions . . . . .	4
2. Approximate Syrup Production from Wood-fired Evaporators . . . . .	5
3. Fuel Oil Requirements . . . . .	6
4. Maximum Allowable Knot Size . . . . .	10

Figure

1. Surface drainage . . . . .	1
2. Sugarhouse located for good draft and air drainage . . . . .	2
3. Basic sugarhouse layout . . . . .	4
4. Open-sided wood storage . . . . .	5
5. Wood carrier mounted on overhead track . . . . .	6
6. Sap storage located on north end of sugarhouse . . . . .	7
7. Sugarhouse processing salesroom . . . . .	8
8. Grain slope . . . . .	10
9. Roof ventilator . . . . .	12
10. Cupola ventilator with side and top roof doors . . . . .	12
11. Large windows for good lighting . . . . .	13

# Sugarhouse Design

Grant D. Wells  
Extension Agricultural Engineer

## SITE SELECTION

Decisions regarding a new sugarhouse start with site selection.

Site selection includes consideration of:

- drainage
- accessibility
- utilities
- air movement (draft)
- space
- convenience and other factors

### Drainage

Selecting a well-drained site is essential in the location of a sugarhouse. Good subsurface drainage is important for the foundation of the building and for year-round access to the site.

The surrounding area should be graded to drain away from the building. You can use diversion terraces or ditches to intercept and divert hillside surface and seepage water from the building site where it is a problem (Fig. 1).

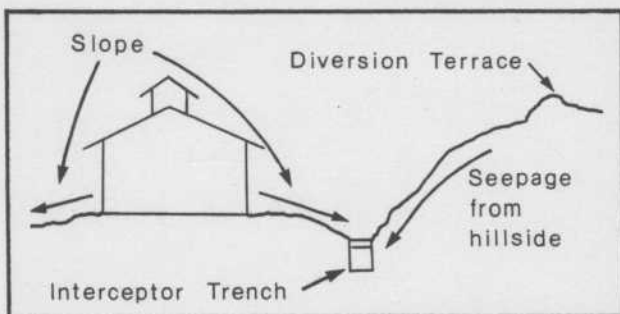

Figure 1. Surface drainage.

Check out the site in late winter and early spring. This is the time of year it will be used and when melting snow, surface runoff, and muddy road conditions can be serious.

### Accessibility

If you can't get to it, how are you going to use it? Locate the building where over-the-road vehicles can be driven to it. And be sure to have an all-weather road or drive because it will be necessary to truck production equipment in and the finished product out. Consider the advantages of accessibility to visitors, potential customers, and suppliers. Sugarhouses located along main highways will retail more maple products than those located off the road and out of sight.

### Utilities

Is electric power and running water readily available at the site? Electricity is a necessity in larger operations with sugar kitchens for processing maple products, and a convenience for even the smallest operations, if for no other reason than lighting. Also, although it may not seem necessary at first, some future expansion or change in operation may call for electricity. Feeder lines of over 500 feet from a meter can be very expensive and anything over 1,000 feet is out of the question. In such a case, you would have to use a power supplier's service drop or an alternative power source. Bottled gas can be used for finishing and packing syrup, and for lighting. An alternative

for lights and other electrical equipment is a portable standby generator operated by a gasoline or diesel fuel engine.

Another fact to consider is fuel supply. Whether the fuel is wood, fuel oil, or some other type, its availability for boiling sap must be assured. Wood storage should be sufficient for one season's run. Fuel oil tanks must be large enough to hold oil for at least 1 day's operation; larger tanks may lower delivery costs.

A supply of clean, running water is necessary for washing filters, strainers, and equipment. Hot water is convenient for cleaning up the more sticky jobs. Keep two things in mind when disposing of the dirty wash water and other waste water: First, this water should not be dumped directly into a watercourse and secondly, concentrated discharges of water can cause erosion if not properly handled.

A toilet is necessary for larger operations with several employees and workers and for year-round site retailing, remote from other buildings. Human waste from toilets must be disposed of in a manner acceptable to health officials. Septic tanks and leach fields are the best methods, but check soil surveys and soil permeability before installing these systems. For seasonal use, a privy may be satisfactory if precautions are taken in its location with respect to the sugarhouse. New composting toilet systems may be acceptable to health officials in the near future. To avoid contamination, locate any system at least 50 feet from the water supply, downwind from the house, and out of sight from the road.

#### Draft and air drainage

Important to the operation of the sugarhouse is proper draft to draw off the va-

pors and steam from the pan surface and to support combustion in the firebox. Therefore, avoid locating the house directly under a knoll or hill, since the wind might blow down on the stack and affect the draft. And keep away from tall evergreen trees because they may affect the draft if close enough to the sugarhouse (Fig. 2).



Figure 2. Sugarhouse located for good draft and air drainage.

Air drainage away from the sugarhouse will improve sanitation. A sugarhouse located in a pocket where cold air tends to settle and stagnate will increase the chance of humid conditions. And surfaces constantly moist encourage mold growth. A sugarhouse located on the side of a hill will have good air drainage as will a house located in the open. Both will remain dryer.

#### Space

As you study various sites, have in mind the approximate size of house you are considering and the amount of clear space around the house required for ac-

cess, ease of operation, and possible future expansion. Pace off the rough dimensions at the site to get an idea of how the buildings and access drives will fit. As a rough measure of total space needed, add a minimum of 20 feet to the building dimensions and allow an additional 40 square feet per vehicle for parking and turning. The access drive should be at least 12 feet wide.

### Other factors

Other factors may play an important part in site selection. A building constructed on a sloping site can be designed to make use of gravity for dumping sap into holding tanks and for running sap from holding tanks to the evaporator.

A location central to the sugarbush can save time gathering sap and tubing for vacuum systems. But this savings has to be balanced against the convenience of locating close to an all-weather road and the advantages of locating close to your home, which encourages full family participation and reduces time-consuming travel. Also, consider visibility; a sugarhouse clearly visible from a well-traveled road can attract visitors and potential customers and will discourage vandalism during the off-season.

Remember, select a site to allow room for possible future expansion. Don't box yourself in.

### SANITATION

A primary concern in location, design, and construction of the sugarhouse is sanitation. The inside of the house and its immediate surroundings must be clean, dry, and free of contamination.

- The house design must allow for ease of cleaning.

- A dry house will reduce chances of mold growth. Choose a well-drained site—sloped and graded—to take care of the disposal of surface water. And insure proper air drainage to keep the house dryer.
- Locate an adequate distance from possible sources of contamination.
- Be sure to have good, tight construction with easily cleaned floors; concrete is the only kind of floor recommended.
- Lots of light is necessary for good vision and improves the psychological outlook of the workers. Plenty of working room around the evaporator is also important. These conditions improve the likelihood of good sanitation.
- A good supply of fresh water under pressure makes it easier to clean up around the sugarhouse processing room.

Sanitation is the key to making quality maple syrup and is increasingly becoming an important criterion for the sale of maple syrup to the public.

### SIZING THE SUGARHOUSE

The sugarhouse should be large enough so that all operations planned, present and future, can be carried on without congestion. Provide plenty of working room, especially around the evaporator—the heart of the operation. Lots of room enhances order, and order encourages a clean, sanitary operation.

The four main components of the sugarhouse and supporting facilities as shown in Fig. 3 are the evaporator room (the basic house), fuel storage, sap storage, and syrup processing room (sugar kitchen).

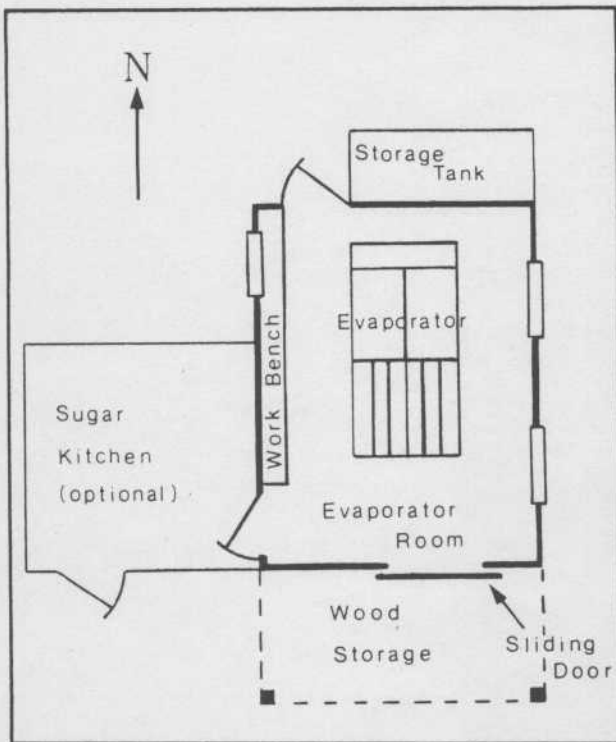

Figure 3. Basic sugarhouse layout.

### Basic house

The size of the basic sugarhouse depends on the size of the evaporator selected, which in turn is based on the number of taps (or trees) in the sugarbush or the number of gallons of sap to be processed each day, and the number of hours the rig will be operated on an average day.

To estimate the size of the building required, determine the exact size and shape of the evaporator selected. (The manufacturer will have this information along with the rated capacity of the rig.) Pick an evaporator with a slightly larger capacity than you think you need. No doubt the number of taps in the bush will increase in only a few years operation.

The basic building should include room for the evaporator, a minimum of 4 feet of work room around the evaporator, and allowance for 4 feet along one wall for a

work bench and additional work area. If there are to be work benches along both walls, allow at least 6 feet to each side of the evaporator. Allow 6 to 10 feet in front of the arch for plenty of room to fuel the firebox and to store some wood inside the house if desired. Typical sugarhouse dimensions are presented in Table 1.

Table 1. Recommended Sugarhouse Dimensions

<u>Number of taps</u>	<u>Minimum size house recommended</u>
150 or less	14' x 16'
up to 1,500	16' x 20'
over 1,500	18' x 24'

An open evaporator pan should be located near the center of the building, directly beneath the ventilator doors in the roof or cupola overhead. Hooded evaporators remove the steam through specially designed stacks and, therefore, can be located to one side of the building.

If your future plans call for a sugaring-off arch or finishing pan, allow space by setting the syrup arch a little to one side of the building, leaving room for the sugar arch at some future date.

Work benches along the wall should be about 36 inches high and they can be from 2 to 2½ feet wide.

### Fuel storage

Heat is required to evaporate the water from the sap to produce syrup. The amount of water to be evaporated varies from as much as 86 to less than 20 gallons per gallon of syrup, depending on the sugar content of the sap.

Wood: The size of your woodshed will depend upon the size of your operation.

Usually 1 cord of dry hardwood is needed for every 75 to 100 taps. A shed 8 by 16 feet stacked with wood to a depth of 5 feet contains 5 cords—enough for 400 to 500 taps; or if stacked 8 feet deep, 8 cords—enough for about 600 to 800 taps. See Table 2 for expected syrup production from specific species of wood.

Wood should be air dried about 1 year to be considered dry. Protect your wood from the elements by a good roof. But be sure the sides and end are not too tight because good air circulation is necessary to dry wood properly. Many woodsheds do not have any sides at all (Fig. 4). If you are in a windy location, board up one or two sides to keep the snow from blowing in.

The woodshed is generally located at the end of the sugarhouse nearest the fire-chamber of the arch. Doors are construc-

ted between the sugarhouse and woodshed for ease in obtaining the wood for the fire-box and to help maintain the draft needed for the fire in the arch.



Figure 4. Open-sided wood storage.

Wood carrier: To decrease the amount of labor involved in getting the wood from the shed to the arch, a track

Table 2. Approximate Syrup Production from Wood-fired Evaporators

<u>Species of Wood</u>	Gallons of syrup expected from 1 cord of air-dried wood by percent sugar in sap				
	<u>1.5%</u>	<u>2.0%</u>	<u>2.5%</u>	<u>3.0%</u>	<u>4.0%</u>
Apple, American Beech, Rock Elm, Hickory, Ironwood, Black Locust, White Oak	25	33 1/3	42 1/2	50	66 2/3
White Ash, Birch, Sugar Maple, Red Oak, Black Walnut	21	28	35 3/4	42 1/4	56 1/4
Black Ash, Green Ash, Black Cherry, American Elm, Red Maple, Silver Maple, Pitch Pine, Red (Norway) Pine, Tamarack (Larch)	17 1/3	23	29 1/3	34 3/4	46 1/4
Aspen (Poplar), Basswood, Butternut, Balsam Fir, Hemlock, White Pine, Spruce, Willow	13 1/3	17 3/4	22 3/4	26 3/4	35 3/4

Assumptions: 1 cord = 128 cubic feet wood and air or 80 cubic feet of solid wood at 20% moisture content. Heating value of one pound of dry wood is 7,700 Btu. Efficiency of the burning unit is 50%.

can be mounted under the roof of the shed extending through the doors to the end of the arch. A platform is then hung from an overhead track (Fig. 5). The platform can be loaded with wood, pushed to the arch, and used as needed. A four-wheeled cart mounted on rails running through the shed and up to the arch is another way of doing the same thing. An example of this is shown in the perspective view of the sugarhouse on the first page in Appendix B. Hardwood timbers can be used for the rails, anchored in place with short posts.

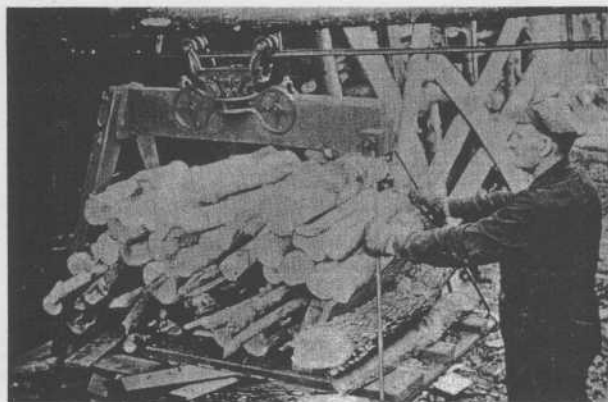

Figure 5. Wood carrier mounted on overhead track.

Woodchips, sawdust, wood residue:

The heat value of these materials varies considerably because of their variation in moisture content and differences in their makeup. Heat utilization ranges from 2,800 to 5,000 Btu per pound. Storage requirements will range from 4 to 8 tons per 100 taps—or on basis of volume, 150 to 350 cubic feet per 100 taps. Wood residue wetter than 60 percent requires more heat to drive off the free water than it will give off when it burns. Thus, extremely wet residue needs some kind of predrying or aging in a pile or windrow for it to dry sufficiently for use.

Fuel oil: If you are considering fuel oil, Table 3 will be helpful. It takes about

1 gallon of No. 2 fuel oil burned at 70 percent efficiency to evaporate 10 gallons of water. Using 2½ percent as average sugar content, 3.3 gallons of fuel oil are required per gallon of syrup produced—or in other words, 3.3 gallons for every tree tapped. This is a seasonal requirement.

Table 3. Fuel Oil Requirements

<u>% sugar in the sap</u>	<u>Gal. of sap/ gal. of syrup</u>	<u>Gal. of oil to remove excess water from sap</u>
1.0	86.0	8.5
1.5	57.3	5.6
2.0	43.0	4.2
2.5	34.4	3.3
3.0	28.7	2.8
3.5	34.6	2.4
4.0	21.5	2.1
4.5	19.1	1.9

Assumption: Fuel oil heating value of 140,000 Btu per gallon burned at approximately 70% efficiency

As a minimum, size the fuel tank on the basis of 1 gallon per 10 taps if fuel supply is dependable and delivery quick; otherwise use a figure of 3 to 5 gallons per 10 taps.

An evaporator furnace designed to use a combination of fuels, such as oil and woodchips, can save considerably on fuel oil. The fire is started and maintained with fuel oil; woodchips are then burned to supply much of the heat required for evaporation.

Sap storage tanks

Location of the storage tank for sap will depend to a certain extent upon the terrain around the sugarhouse. Because the storage tank should be located in a



cool area, the north side of the house is desirable (Fig. 6). The east side of the house is an alternative location. If the shed is placed on the north side, keep in mind that some provision should be made for cleaning the arch from that end as well as the ash pit end. One way is to set the tank on a platform high enough above the ground to permit clean-out below the platform. This will probably be done anyway for gravity feed from the storage tank to the evaporator. The roof of the shed should be designed to keep water out of and off the tank.



Figure 6. Sap storage located on north end of sugarhouse. Note gravity feed line.

Storage tanks should be large enough to store at least 1 day's run, preferably 2, in case of equipment breakdown, rest days, or simply a very good run. On days when sap flows well, 100 to 400 gallons of sap may be produced per 100 tapholes. Plan on a minimum of 1 gallon of storage per tap if buckets are used to collect the sap,  $1\frac{1}{2}$  gallons for gravity systems, and 2 gallons for vacuum systems with temporary containers handy for extra-good runs. All holding or storage tanks do not have to be next to the sugarhouse, but they should be covered. Storage periods greater than 2 days greatly increase the chances of sap spoilage.

For gravity feed, the bottom of the storage tank should be at least 3 inches above the top of the evaporator. (Evaporator pans are usually 4 feet above the floor.) If sufficient elevation is available, the collecting and hauling tank can be unloaded by gravity into the storage tank. This can be accomplished on building sites with average grades of 20 to 25 percent (1:5 to 1:4) or greater. Flatter grades require excessively long transfer hoses or troughs. Roadways can be built up to achieve gravity transfer. Where gravity transfer cannot be achieved, pumps will be required.

Tanks must have easy access for cleaning and repair. Metal or glass-lined tanks, such as surplus bulk milk tanks, are ideal since their walls are nonporous and easy to clean. If you choose these insulated tanks, make provisions to precool or sterilize the sap before it enters the tank because an insulated tank not only will keep cool sap cool, it will keep warm sap warm. Large storage tanks should also be provided with an agitator and germicidal, ultraviolet lamps to prevent microbial growth. Germicidal lamps should also be used over any open troughs used for sap

transfer. (Take care never to expose eyes to ultraviolet lamps.)

#### Syrup processing room (sugar kitchen)

Attractive packaging and quality control help build your image thereby increasing sales. If the evaporator house is to be a single room, you must provide space for filtering the syrup and for packaging it. It is better to process the syrup in a second room built as a wing to the evaporator room. (See Cornell Sugarhouse Plan, Appendix B). This arrangement does not add appreciably to the cost of construction, and it allows the syrup to be processed under better working and sanitary conditions.

A processing room houses such operations as heating, filtering, and packaging the syrup, and making maple confections. The equipment can consist of a filter rack, a stove for boiling the syrup, a maple cream beater, and sugar stirrers among other things. There should be a sink for dish washing, a hot water heater, and a trough with cold running water in which syrup that has been cooked for making maple cream or sugar candy can be cooled rapidly. Storage space should be provided for cooking utensils and containers.

If the sugar kitchen is to serve as a retail sales outlet, allow space for storing and displaying the products attractively. An outside door should be provided and a self-closing door between the evaporator room and the processing room is recommended (Fig. 7).

The easiest way to develop plans for this room is to use cross-section paper and scale cutouts representing the various components, equipment, and work centers. Leave 4 feet between counters to allow space for one person to walk past another

using a piece of equipment or working at the counter. Leave 3 feet between island work centers and side counters or walls. Standard counter height is 36 inches and counter width is usually no more than 24 inches. Allow 36 inches of counter frontage for each work station.

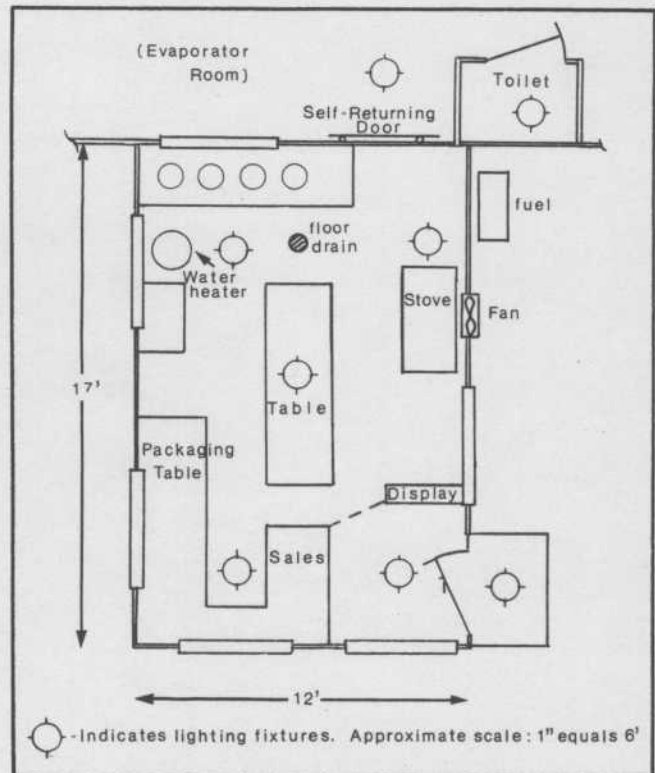

Figure 7. Sugarhouse processing salesroom.

A 12- by 12-foot packaging room/sugar kitchen will probably be sufficient in most operations without retailing. Retailing calls for additional counter space to separate work area from sales area. As a minimum, an additional 6- by 6-foot area for retailing is recommended.

A ventilation fan with a rated capacity of 300 to 500 cubic feet per minute (cfm) will remove vapors and odors given off in the packaging room. The fan should be located over the stove exhausting air to the outside. (This assumes a closed door be-

tween the main evaporator room and the packaging kitchen.) Provide drains for handling waste water from all processing operations.

#### Auxiliary storage

Sealed containers of syrup will keep years without deterioration. You can store containers in the sugarhouse before they are marketed, but store syrup at temperatures as close to 35° F (2° C) as possible until time of sale. Temperatures above 60° F (15° C) may cause darkening of syrup and development of caramel flavor.

The sugarhouse may also be used for storing tanks, buckets, and other equipment during the off-season. Special features may be designed, such as wide doors and drive-through areas, to make it easy to store these items. If you intend to do this, work appropriate dimensions into the sugarhouse design.

Security may be a problem if the house is located away from living quarters. The best that can be done in this case is to leave the building as tight as possible—locked—taking the most easily transported equipment to a safer place.

#### DESIGN AND CONSTRUCTION

There is no substitute for a good, detailed set of plans to aid in construction. You can avoid costly mistakes if such plans are at hand and used. However, sugarhouses not wider than 20 feet can be built using nothing other than rough sketches on paper by persons with experience and skill in construction. Sometimes it is difficult to get detailed plans exactly right to meet your needs, especially when smaller structures are called for. But draw or purchase the best possible plans to avoid mistakes.

Factors to consider in the design of

your sugarhouse include:

- orientation
- construction
- foundation
- floors
- arch foundation
- drains
- walls
- roof
- ventilators
- stacks
- lighting
- entrances
- maintenance
- expansion

#### Orientation

The firebox-end of the arch should either face downhill or toward the prevailing wind. This will result in greater ease of "firing" the rig. If the house is to be out in the open on fairly level land, try to face it toward the south.

#### Construction

Since the sugarhouse is used only 4 to 6 weeks each year, its cost must be kept low; otherwise, the interest on your capital investment is out of proportion to use. You can keep the investment low by using native, home-grown lumber and family labor. Just be sure to construct the building strong enough to resist wind and snow loads, and tight enough for good, clean operation and appearance.

A low-cost method often used for small, single-story buildings is pole construction. Not only is it usually less costly, but the building can be erected faster and the strength equals that of frame construction. Construction techniques are a little different; pressure-treated poles must be used to assure

building life of over 5 years. If the site you have chosen has rocky soils, pole construction is inadvisable. (See Appendixes B and C for examples of pole construction.)

Rough-cut, native, home-grown lumber such as fir, hemlock, or spruce can be used for construction. Pieces to be used as structural (load carrying) members must be air dried at least 1 year. Select lumber on the basis of its freedom from knots, splits, cracks, and seasoning defects, such as warp and checks (Table 4). Slow, uniform drying will reduce the number of discards due to seasoning.

Table 4. Maximum Allowable Knot Size

Lumber size	Maximum knot size
2x4	1"
2x6	1½"
2x8, 2x10, 2x12	2"

Slope of grain in a piece of wood, also known as cross-grain, reduces the strength of the piece. Careful sawing of the log will reduce the number of pieces discarded for this reason (Fig. 8).

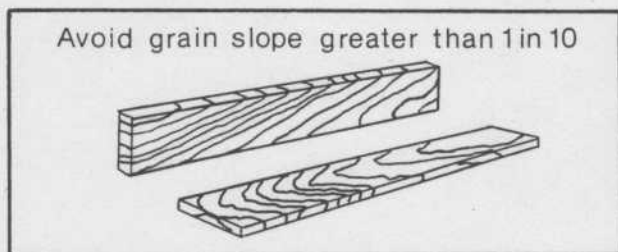

Figure 8. Grain slope.

### Foundation

If water in the soil beneath the foundation should freeze, it can lift the building out of line. For this reason, the foundation is often placed to depths of 4 to 5 feet—sufficient to reach below the frost line. However, for small buildings, foundation

walls 18 to 24 inches deep or setting the building on a concrete slab over a well-drained soil can safely reduce construction costs. You can use concrete blocks for the foundation wall.

### Floors

Four-inch concrete is sufficient for the floors if placed on 6 inches of well-compacted gravel fill and the subsurface soil is well drained. Before placing the gravel fill, the topsoil should be stripped removing all vegetative growth. The floor should slope 1/8 inch per foot toward drains located such that water spilled anywhere on the floor will not pool. It is recommended that the floor in front of the arch be recessed 8 to 12 inches for convenience for firing the box and for ash removal. In pole buildings without concrete foundation walls, the floor should be thickened to 8 inches around the edges, especially where vehicles will be driving in and out. Concrete floors are inadvisable in the woodshed.

### Arch foundation

It is important that the evaporator pans remain level. For this reason, all arches 3 feet by 8 feet or larger should have a foundation. You can use shims to make minor leveling adjustments but they will not take care of major shifts in the floor caused by frost heaving.

Foundation construction may be of cinder block, poured concrete, or a slab of concrete resting on separate pillars placed at the four corners of the arch. The space between the foundation walls can be filled in with gravel and stones. To support the evaporator pan, there should be a pillar or foundation wall under each corner and/or leg extending below the frost line.

Leave a construction joint between the floor and the arch foundation. Then if the floor should crack or shift, it will not affect the leveling of the arch.

It is best to do all concrete and brick work before cold weather sets in because concrete and mortar should not freeze until it has cured. Do not use salt or chloride to prevent freezing where it will come in contact with metal.

### Drains

A good drain consists of a 4-inch tile through the floor, covered with a screen to keep out large particulate matter. The drainpipe should slope to where the water can be safely discharged. A hole through the foundation wall at floor level will work satisfactorily as long as the water drains away from the wall. Because the front (firebox) end is usually on the downhill side, the logical spot for the drain would be out the recessed pit in front of the firebox.

### Walls

There is no advantage in building a high sugarhouse. The studs for the side of the building need not be more than 8 feet, and 7 feet will do just as well if there is enough height for preheaters and the steam stack. A high sugarhouse permits the steam to condense before it leaves, resulting in a continuous drip. Board the sides of the building tight so that no cold drafts can blow across the pan.

### Roof

A clear span is necessary for sugarhouses. Buildings up to 20 feet wide can easily be made with simple rafters and cross-ties at the top of the wall. With wide buildings, construction problems develop because it is difficult to get lumber longer than 20 feet. Therefore buildings wider

than 20 feet require trussed rafters for clear span. Cross-ties are 2x4's or 2x6's and the rafters are 2x6's or 2x8's placed 24 inches on center.

Minimum roof slopes recommended are 4:12 (4 feet rise to every 12 feet of horizontal run) and roof slopes as steep as 1:1 are often used in heavy snow areas. Steeper roof slopes are visually pleasing.

Any good, fireproof roofing material can be used for roofing. Metallic materials are corrugated to provide channels for controlled drainage and have greater lengthwise stiffness to permit installation on an "open" roof. The materials are fastened to roof girts or purlins, which are placed 24 inches on center perpendicular to the rafters. Using nails equipped with a sealing washer, these fasteners are placed on the top of the corrugations to eliminate leakage through the holes.

### Ventilators

Roof ventilators are required for open pan evaporators. You can build the ventilator doors as an integral part of the sugarhouse roof or into the side of a cupola. Roof ventilators swing on hinges from the bottom, and one laps over the other at the ridge. They can be opened or closed with the use of a rope and pulley system and must be water-tight when closed (Fig. 9).

Although it is more difficult to build, a cupola ventilator gives more protection against wet weather (Fig. 10). Rope and pulleys are also used to open and close the doors.

The ventilator should normally be about half the length of the building (evaporator room) and at least as long as the pan. The distance between doors in a cupola should be a minimum of 3 feet and

it will do no harm if the cupola is wider for the largest evaporators. The height of the doors should be 24 inches for smaller rigs to 36 inches or more for the larger ones. Make them large enough so that one door alone will take care of the steam because very often only one door is used, especially when a strong breeze is prevailing in which case the one on the side away from the breeze is opened. As a minimum, a ventilator door should be as wide as one-half the width of the evaporator pan.

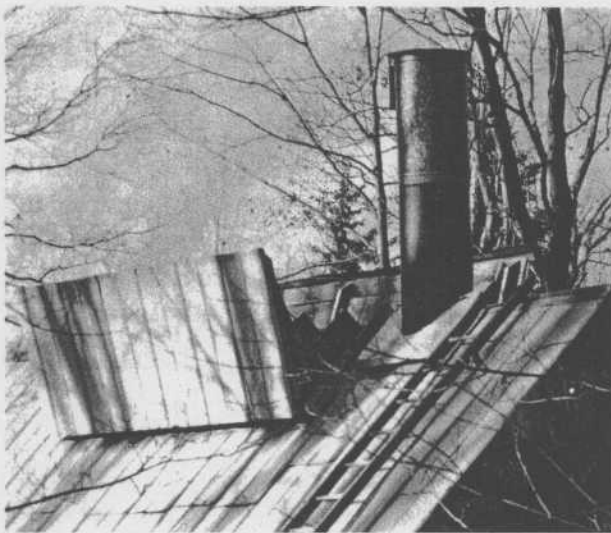

Figure 9. Roof ventilator.

It is possible to construct a sugarcane house so tight that there is not sufficient air intake to take care of the fire and the steam draft, too. If the sides are really tight, a small, hinged door on either side of the arch just above the foundation walls will take care of the steam requirements; the door opening to the woodshed will take care of the fire draft. Hooded evaporators do not require extensive roof openings, but they do need one or more steam vent stack openings.

### Stacks

The stack, or chimney, should extend

well above the building to insure a good draft. A rule of thumb has been that it should be approximately as high as the arch is long (for wood, twice as high as the arch is long). However, a number of factors affect the draft of the stack, including the temperature of the gases up the stack as well as the building surroundings. Make allowance for the possibility that stack lengths may need to be changed for good draft.

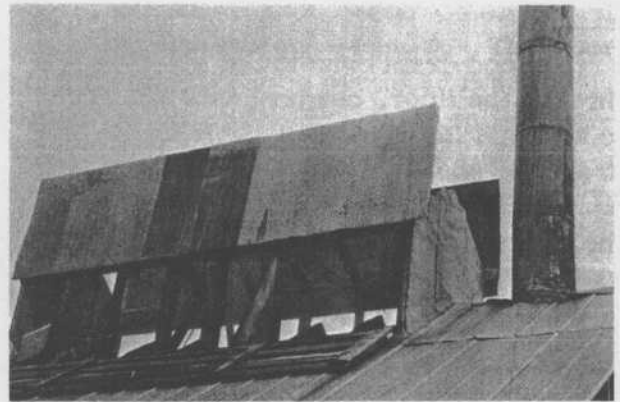

Figure 10. Cupola ventilator with side and top roof doors.

Some sugarmakers build the ventilator so that the stack comes up through it. In this way, the heat from the stack helps to suck the steam up through the ventilator.

When not in use, the stack should be taken down and stored in a dry place inside the house. Be sure the hole in the roof for the stack is slightly oversized to allow for stack removal. Then cover the hole during the off-season.

### Lighting

Put in plenty of windows as light is essential (Fig. 11). Windows over work benches facilitate tasks at these areas while windows in the gables can be used to ventilate the building if you use closed hood evaporators.

Fiberglass reinforced plastic (FRP) panels, shaped to match metal roofing and/or siding panels, can be used for natural lighting. Available in several colors—primarily green, yellow, and white—these panels allow interior daylight, but are not clear enough to see through.

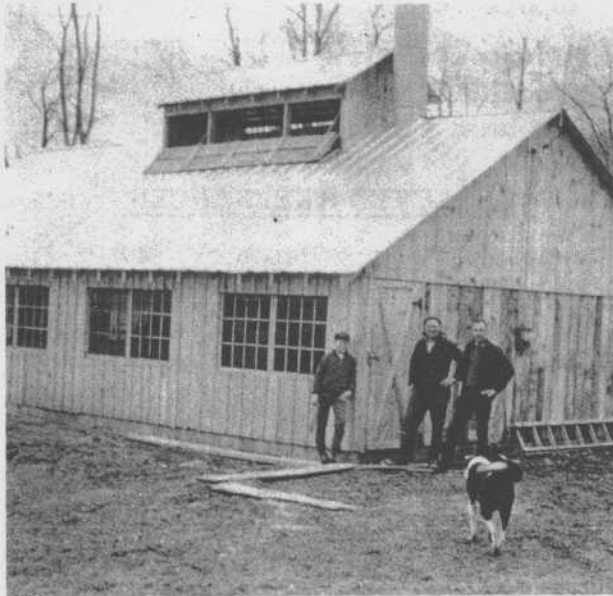

Figure 11. Large windows for good lighting.

Plastic skylight area should not exceed one-twentieth (5 percent) of the roof area because FRP panels cost three to five times more than the steel or aluminum roofing and often cause high building temperatures in the summer. Use a sealant around skylight panels to prevent leakage.

Artificial lighting is important for sanitation, a good finished product, and night operation. Illumination should be of two types: General lighting and task lighting. General lighting consists of one lighting socket for every 150 to 200 square feet located at ceiling height. Task lighting is needed for individual jobs; 100 watt incan-

descent or 20 watt fluorescent lamps at each work area will do. Outdoor lighting should be included for night visibility and safety.

### Entrances

Doors should be provided for ease of getting fuel to the arch and for removing ashes and cleaning the arch. You'll need sidedoors, also, to provide access for people, and if desired, large doors for storing equipment during the off-season. One set of doors at the end of the building, 2 feet wider than the evaporator, will be handy when it comes to installing the new evaporator. For fire safety, the sugarhouse should have a minimum of two doors, one located at each end of the building. These doors should always be easily opened and never blocked as long as there are people working in the house.

### Maintenance

Your sugarhouse will require a minimum of maintenance. The most important thing is to keep the roof in good repair. Remember, moisture is the chief villain of buildings so make sure the ventilators are tightly closed after the last run of the season. And repair any leaks as soon as they are spotted. Metal roofs need painting every 7 years or so depending on the quality of the roofing to prevent rusting. Paints, stains, or preservatives help protect the siding; they need to be renewed every 4 to 5 years.

Leave the inside of the building as clean as possible. Eliminate harbors for rodents and holes where birds can enter.

### Expansion

You can expand your sugarhouse operation in several ways: You can in-

crease the number of taps or amount of sap boiled down, or you can add equipment for increased efficiency or for further processing.

Sugarhouses built a little oversized to begin with can accommodate some expansion. Adding rooms to the side of the main frame will allow more. In some cases, where the size of the evaporator required outgrows the structure, the house can be lengthened if there is space.

### SUGARMAKER'S RATING SHEET

The following rating sheet on buildings and grounds is part of a more extensive list including equipment and operating procedures prepared by the Market Development Division, Vermont Department of Agriculture, in cooperation with the Vermont Maple Sugarmakers Association, the Vermont Extension Service, and the Vermont Maple Industry Council.

#### Rating Sheet: Buildings and Grounds

	<u>Satisfactory</u>	
	Yes	No
A. Well-drained site, sloped and graded for disposal of surface water	_____	_____
B. Location—adequate distance from possible source of contamination (manure pile, feedlots, etc.)	_____	_____
C. Outside appearance—neat, clean, free of trash	_____	_____
D. Construction—good repair, tight	_____	_____

- E. Floor—tight, easily cleaned, properly sloped for draining (concrete recommended) \_\_\_\_\_
- F. Light—natural or artificial sufficient for good vision at all times \_\_\_\_\_
- G. Inside arrangement conducive to sanitary operation \_\_\_\_\_
- H. Plenty of working room around evaporator (at least 4 feet) \_\_\_\_\_

### SELECTED REFERENCES

Farmstead Planning Handbook, MWPS-2. 1974. Midwest Plan Service, Department of Agricultural Engineering, University of Iowa, Ames, Iowa 50010. \$2.00.

Maple Syrup Producers Manual, Agriculture Handbook No. 134, revised June 1965. Superintendent of Documents, U.S. Government Printing Office, Washington, D. C. 20402. \$2.50. (Also available from Publications, Morrill Hall, University of Vermont, Burlington, Vermont 05401 at same price.)

Pole and Post Building Construction, NRAES-1, revised 1977. Northeast Agricultural Engineering Service, Riley-Robb Hall, Cornell University, Ithaca, New York 14853. \$1.25.

Sugarhouse plans from UVM Plan Service. Order from: Plan Service, Agricultural Engineering Building, University of Vermont, Burlington, Vermont 05401. (Three of these plans are included in the Appendixes of this bulletin.)



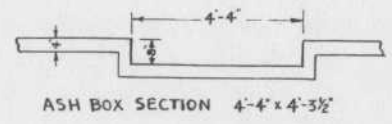
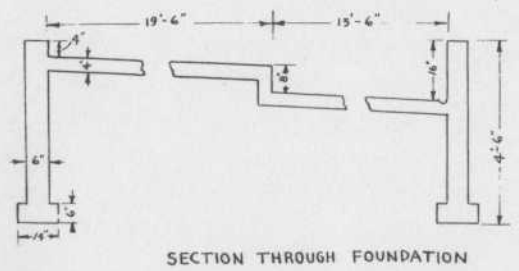
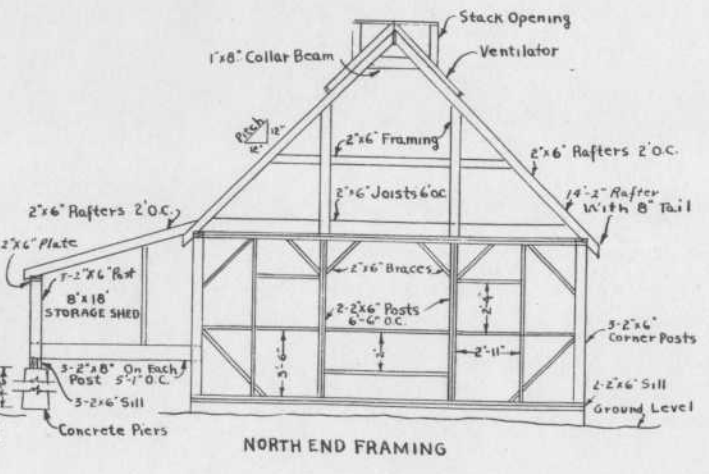
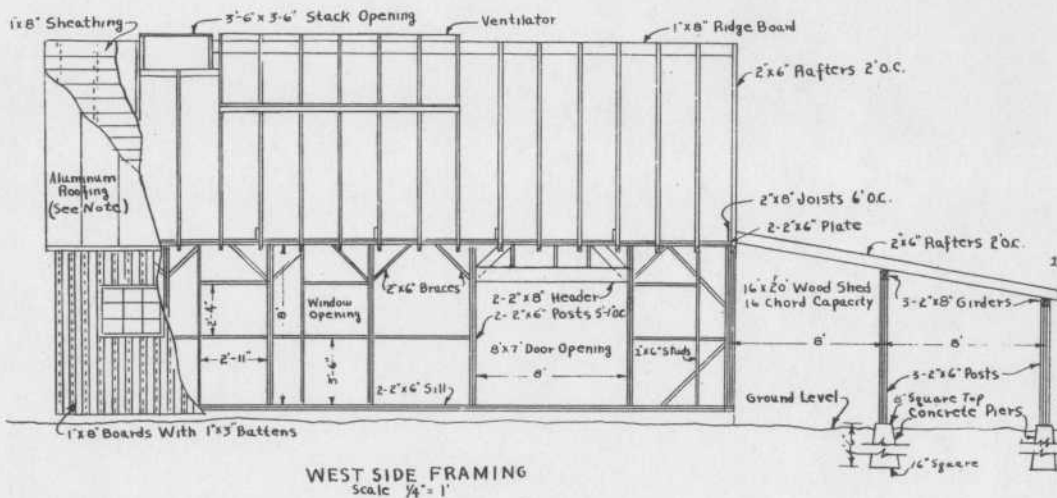
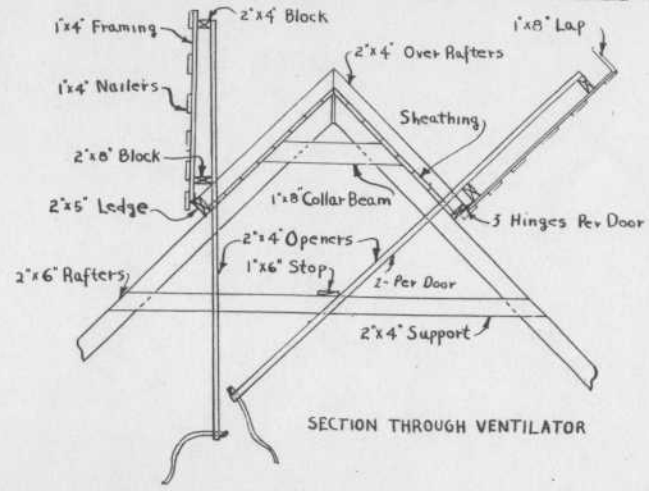
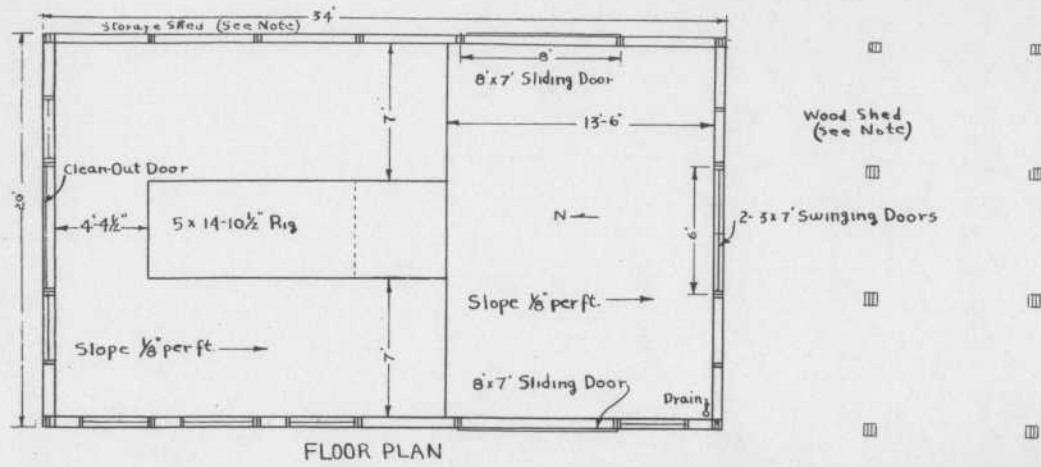

AGRICULTURAL ENGR. DEPT.	
UNIVERSITY OF VERMONT	
<b>SUGAR HOUSE</b>	
DATE: 11/26/48	SHEET 1 OF 1
M.W.S.	PS-1

LIST OF MATERIALS: VERMONT SUGARHOUSE (Plan #PS-1)

LUMBER:

<u>No. required</u>	<u>Size</u>	<u>Length (ft.)</u>	<u>Bd. Ft.</u>	<u>Grade</u>	<u>Remarks</u>
200	2x6	12	2390	Spruce (rough)*	Posts Studs Plates
36	2x6	16	576	Spruce (rough)*	Rafters Sills
44	2x8	12	705	Spruce (rough)*	Girders Joists Window Sills
14	2x4	12	112	Spruce (rough)	Framing
172	1x8	12	1650	White Pine (rough)	Sheathing
208	1x8	12	2000	White Pine (planed on one side)	Siding
184	1x3	12	500	White Pine (planed on one side)	Battens

\*Hemlock could be used as well as spruce for 2" x 4" and 2" x 6".

CONCRETE:

7 gallon mix  
 Cement--85 bags  
 Sand--9 cubic yards  
 Gravel--13 cubic yards

} 1:2 3/4:4 (cement:sand:gravel ratio)

HARDWARE:

30 lb. 6d nails	4--end brackets
125 lb. 20d nails	2 sets door hinges
125 lb. 8d nails	1--bell trap drain
6--2'-11" x 2' - 4" single sash windows	4--door stays
20--1/2" x 7 1/2" bolts	2--track splice brackets
1 pair of heavy tee hinges	6--intermediate brackets
20 ft. litter carrier track	48--1/4 x 2 1/4 bolts
7--10 1/4 hangers	54 sheets of 10' aluminum roofing
2--litter carrier pulleys	18 sheets of 8' aluminum roofing
10--2' x 4" tile	34 sheets of 6' aluminum roofing
1--4" 90 elbow	40 ft. ridge rool
4--2 way hinges	roofing nails
30 ft. door track	

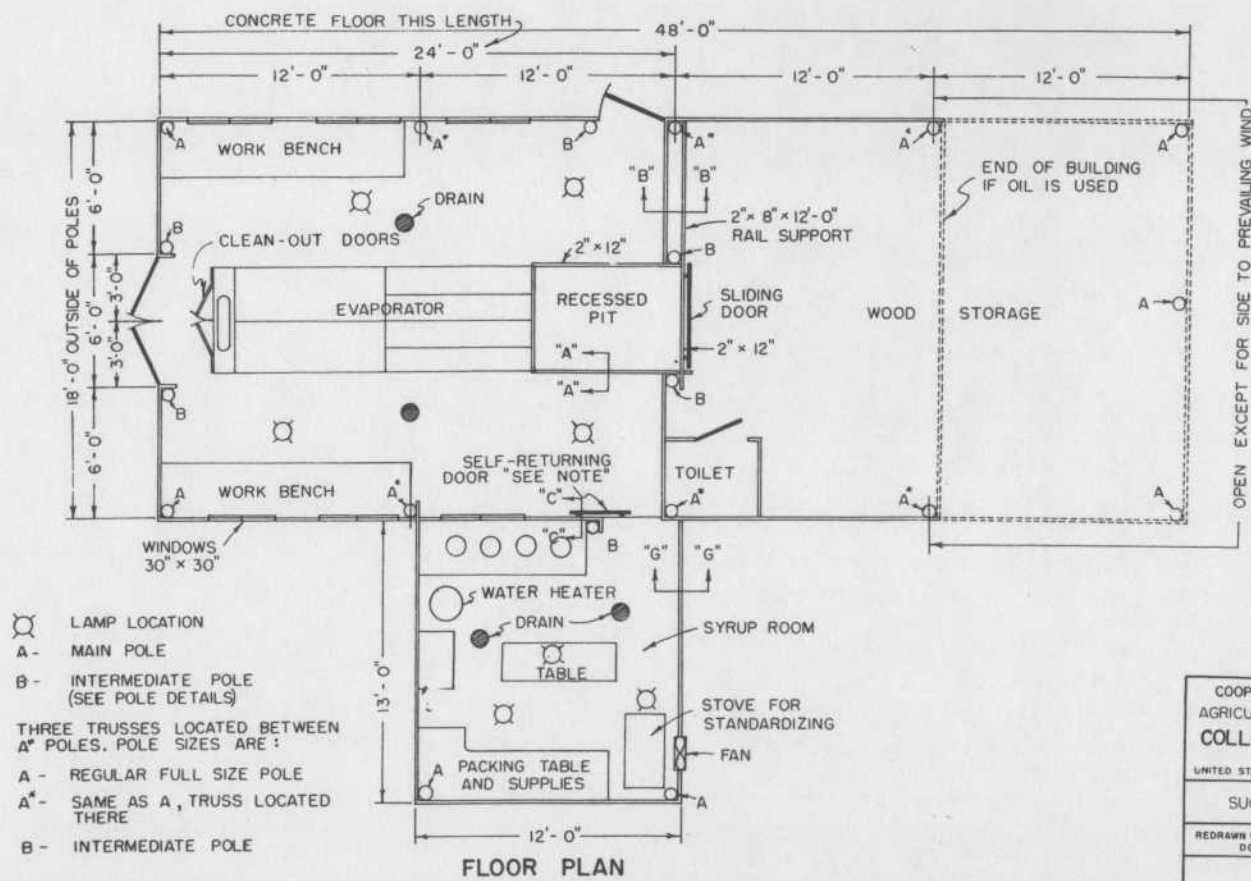
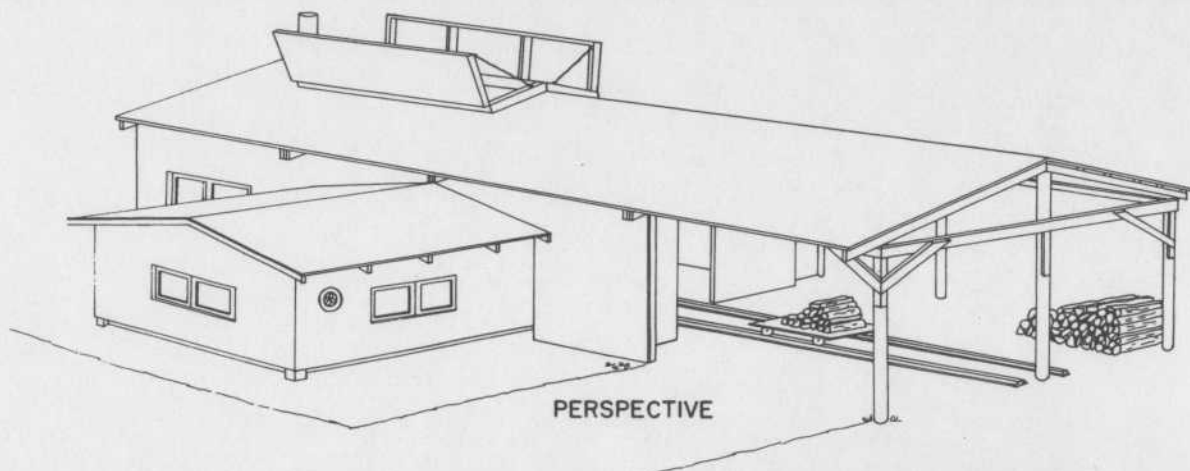

○ LAMP LOCATION

A - MAIN POLE

B - INTERMEDIATE POLE  
(SEE POLE DETAILS)

THREE TRUSSES LOCATED BETWEEN  
A\* POLES. POLE SIZES ARE:

A - REGULAR FULL SIZE POLE

A\* - SAME AS A, TRUSS LOCATED  
THERE

B - INTERMEDIATE POLE

COOPERATIVE EXTENSION WORK IN  
AGRICULTURE AND HOME ECONOMICS  
**COLLEGE OF AGRI. UNI. OF VT.**

AND  
UNITED STATES DEPARTMENT OF AGRICULTURE COOPERATING

SUGAR HOUSE (CORNELL UNI.)

REDRAWN - 1966 DCB	EX. VT. 116	SHEET 1 OF 4
-----------------------	-------------	--------------

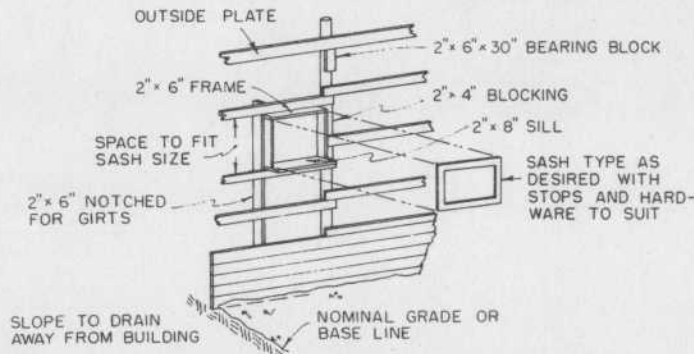
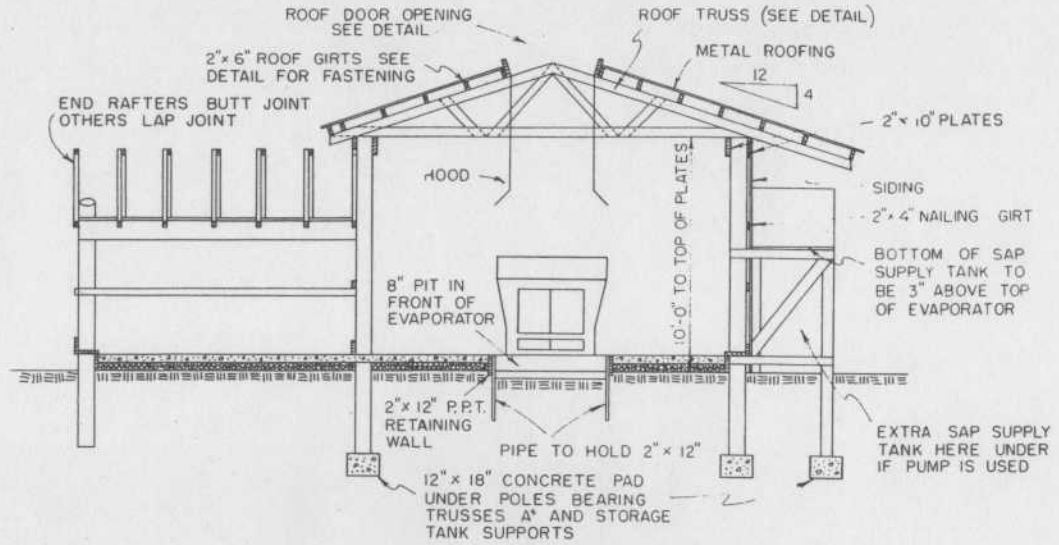
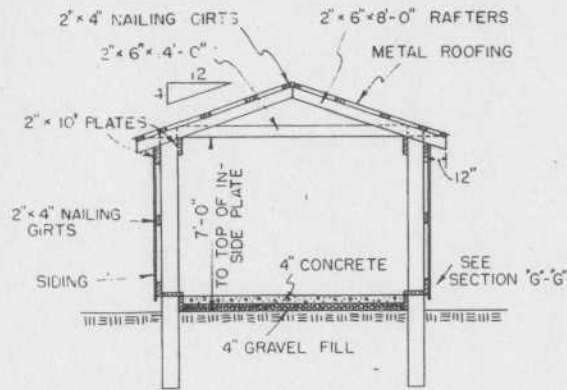

WINDOW DETAIL

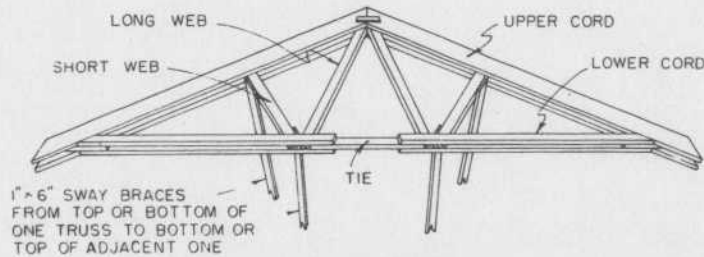

ROOF TRUSS

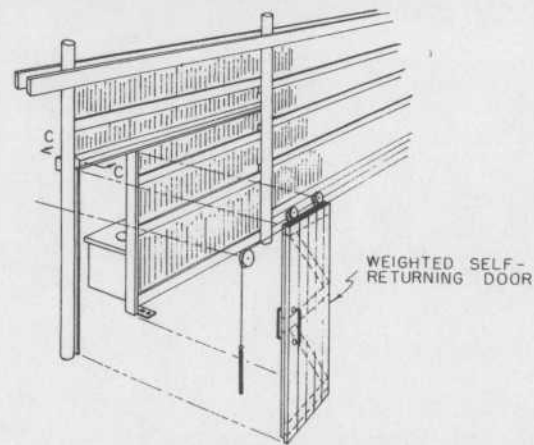

SELF RETURNING DOOR TO SYRUP ROOM

COOPERATIVE EXTENSION WORK IN AGRICULTURE AND HOME ECONOMICS		
COLLEGE OF AGRI. UNI. OF VT.		
AND UNITED STATES DEPARTMENT OF AGRICULTURE COOPERATING		
SUGAR HOUSE (CORNELL UNI.)		
REDRAWN 1968 DCB	EX. VT. 116	SHEET 2 OF 4

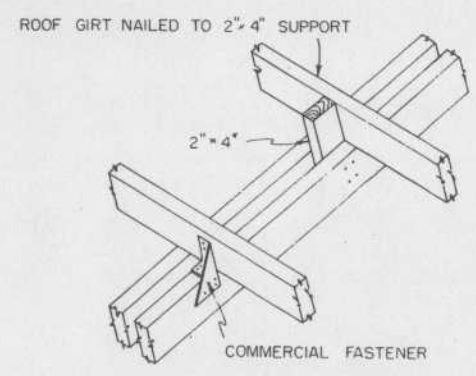
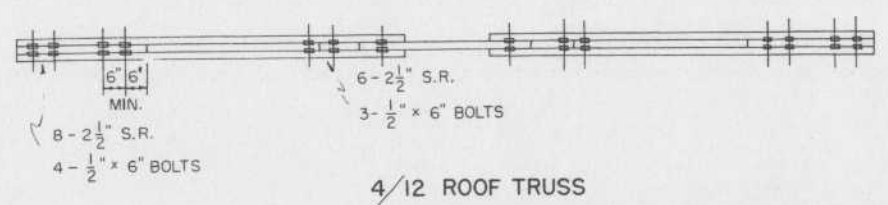
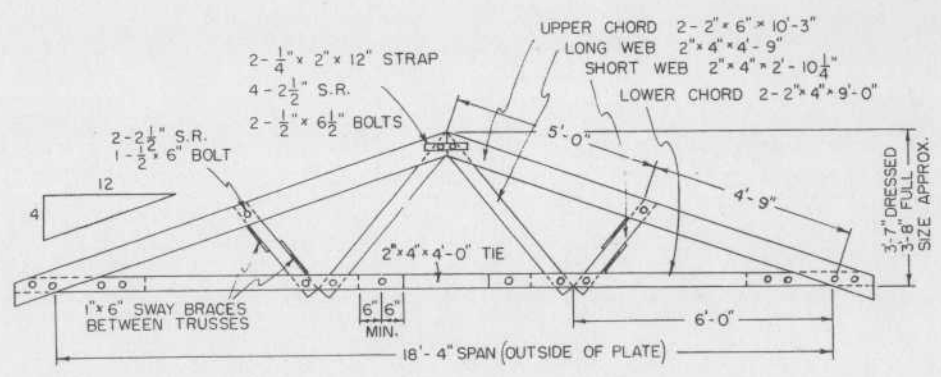
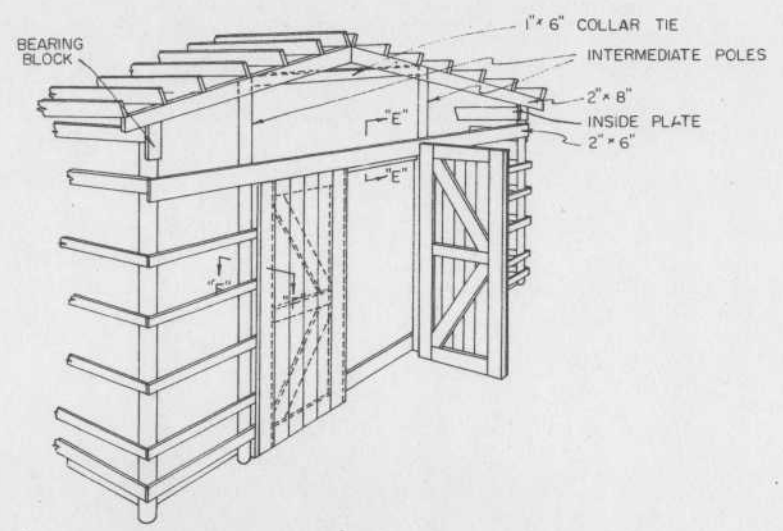
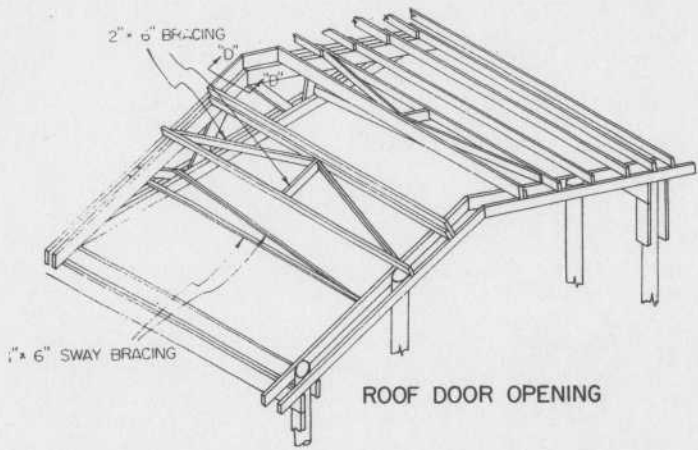

ALTERNATE METHODS OF FASTENING  
ROOF GIRTS TO TRUSS

COOPERATIVE EXTENSION WORK IN  
AGRICULTURE AND HOME ECONOMICS  
COLLEGE AGRI. UNI. VT.  
AND  
UNITED STATES DEPARTMENT OF AGRICULTURE COOPERATING  
SUGAR HOUSE (CORNELL UNI.)  
REDRAWN 1965 EX. VT. 116 SHEET 3 OF 4  
DCB

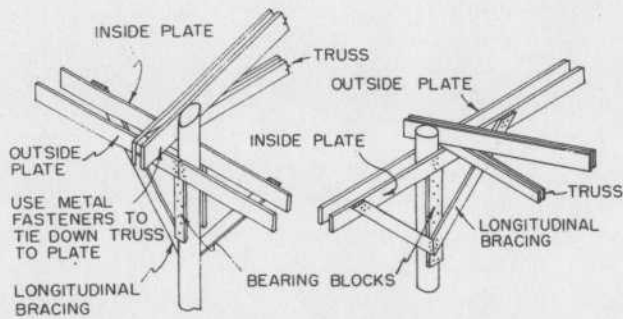
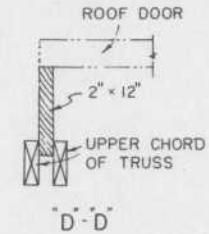
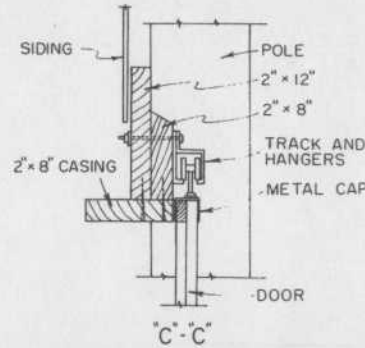
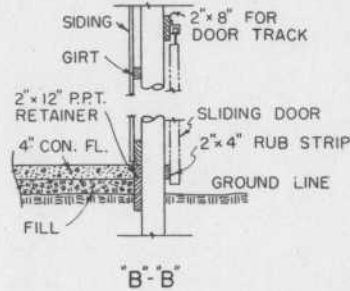
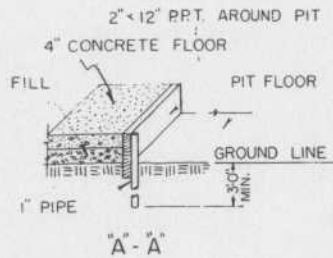
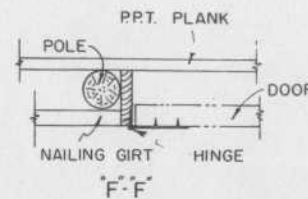
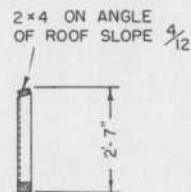
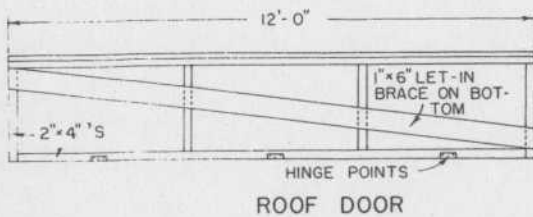
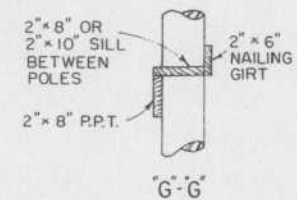
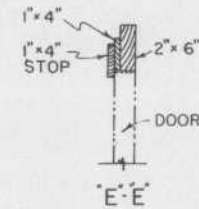
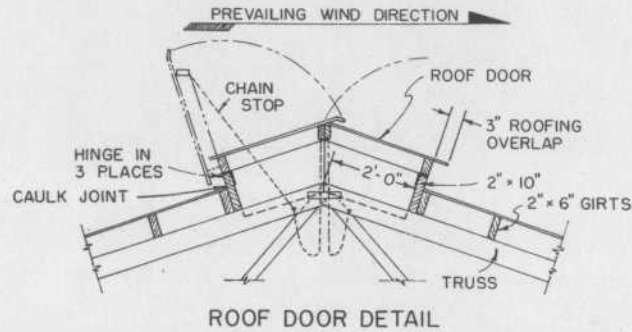

PLATE DETAIL



COOPERATIVE EXTENSION WORK IN AGRICULTURE AND HOME ECONOMICS  
COLLEGE OF AGRI. UNI. OF VT.  
AND  
UNITED STATES DEPARTMENT OF AGRICULTURE COOPERATING

SUGAR HOUSE (CORNELL UNI.)

REDRAWN 1966 DCR EX. VT. 116 SHEET 4 OF 4

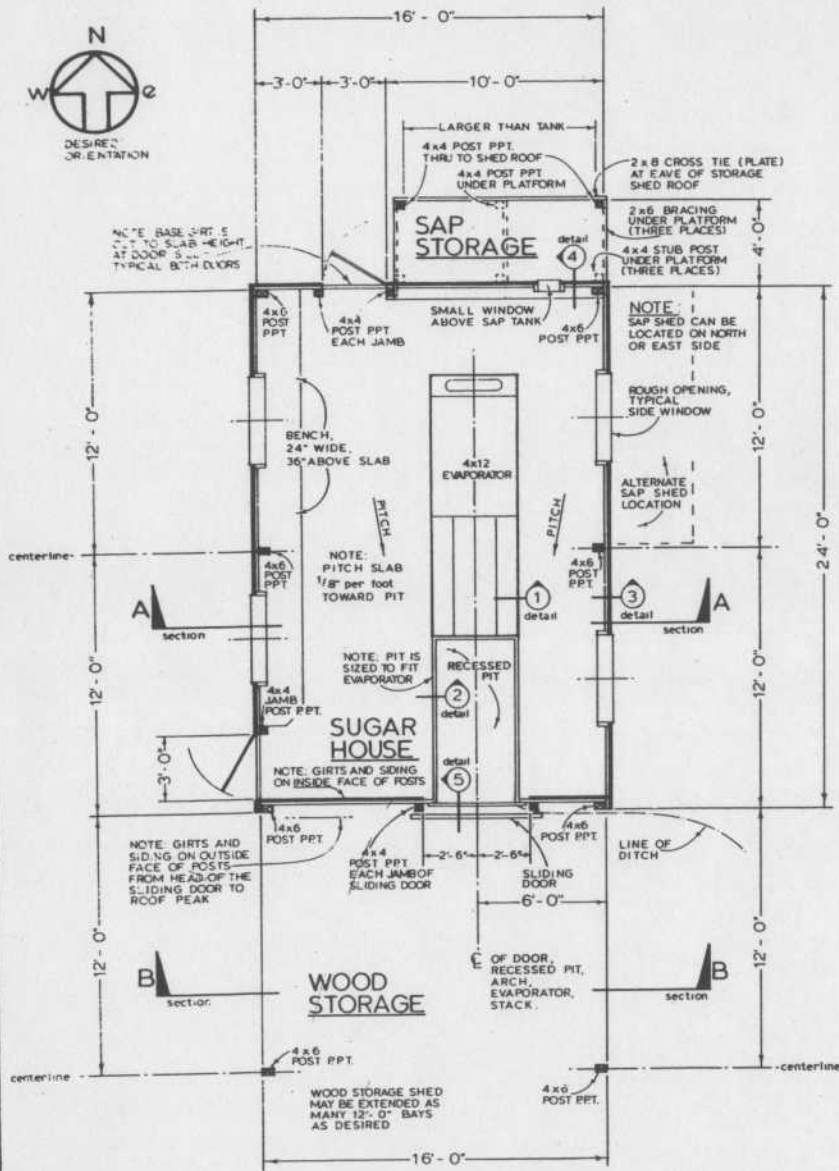

FLOOR PLAN



GRAPHIC SCALE

**SANITATION NOTES:**

PLANS SHOULD BE MADE FOR ADEQUATE PREPARATION AND DISPOSAL OF HOT WATER FOR WASHING FILTERS, AND FOR WASHING PANS BETWEEN SAP RUNS.

SAP STORAGE SHOULD BE EQUIVALENT TO ONE GALLON PER TAP IF PLASTIC TUBING IS USED, (1/2 GALLON PER TAP IF BUCKETS ARE USED).

SAP STORAGE TANKS SHOULD BE EQUIPPED WITH COVER AND WITH FILTERS.

TANKS SHOULD BE WASHED WITH A ONE TO 20 CLOROX SOLUTION BETWEEN SAP RUNS AND AT END OF SEASON. AVOID SOLUTIONS WHICH ARE TOO STRONG.

STEAM HOODS BUILT OF WOOD AND PLASTIC ABOVE THE EVAPORATOR TO THE CUPOLA WILL HELP TO VENT STEAM FROM THE SUGAR HOUSE. LEAVE TROUGHS FITTED AT THE BOTTOM OF THE HOOD WILL LEAD CONDENSED STEAM AWAY TO A TANK OR PAIL AT THE END OF THE ARCH.

DISPOSABLE FILTERS, BOXES, NITER, AND OTHER TRASH SHOULD BE REMOVED FROM THE SUGAR HOUSE EACH DAY.

**GENERAL NOTES:**

BASIC DESIGN IS FOR 4x12 EVAPORATOR.

EVAPORATORS UP TO 5x14 CAN BE INSTALLED PROVIDING VENTS ARE ENLARGED.

LARGER BUILDINGS ARE RECOMMENDED FOR EVAPORATORS LARGER THAN 5x14.

**EFFICIENCY NOTES:**

SIDES OF ARCHES INSULATED WITH ASBESTOS, FIRE-BRICK, AND KAOWOOL WILL PREVENT HEAT LOSS AND INCREASE THE EFFICIENCY OF THE FUEL IN BOILING SAP.

A METAL HOOD FITTED WITH A PRE-HEATER TO USE THE HEAT OF THE STEAM FOR RAISING THE TEMPERATURE OF BOILING SAP WILL IMPROVE EFFICIENCY IN THE USE OF HEAT BY 14 TO 17 PERCENT.

LIGHTS FITTED INSIDE AND OUTSIDE THE SUGAR HOUSE WILL ALLOW SAFE ACCESS AND BOILING AT NIGHT WHEN HEAVY SAP RUNS OCCUR.

FOR BEST PRODUCTION OF HIGH QUALITY SYRUP, SAP SHOULD BE BOILED THE DAY THAT IT RUNS. SAP SHOULD BE ABOUT ONE INCH DEEP IN PANS WITH REGULATORS PROPERLY SET.

**SPECIFIC NOTE:**

ALL POSTS, BASE GIRTS, AND OTHER LUMBER IN CONTACT WITH THE GROUND SHALL BE PRESSURE PRESERVATIVE TREATED. (P.P.T.).



BIRD'S EYE PERSPECTIVE FROM NORTH-EAST

VERMONT EXTENSION SERVICE  
COLLEGE OF AGRICULTURE  
VOTEC DEPARTMENT  
UNIVERSITY OF VERMONT

16x24 SUGAR HOUSE

USDA	VT EX 200	SHEET 1 OF 3
DRAWN BY LBC	CHECKED BY G.D.W.	DATE 30 JUNE 77

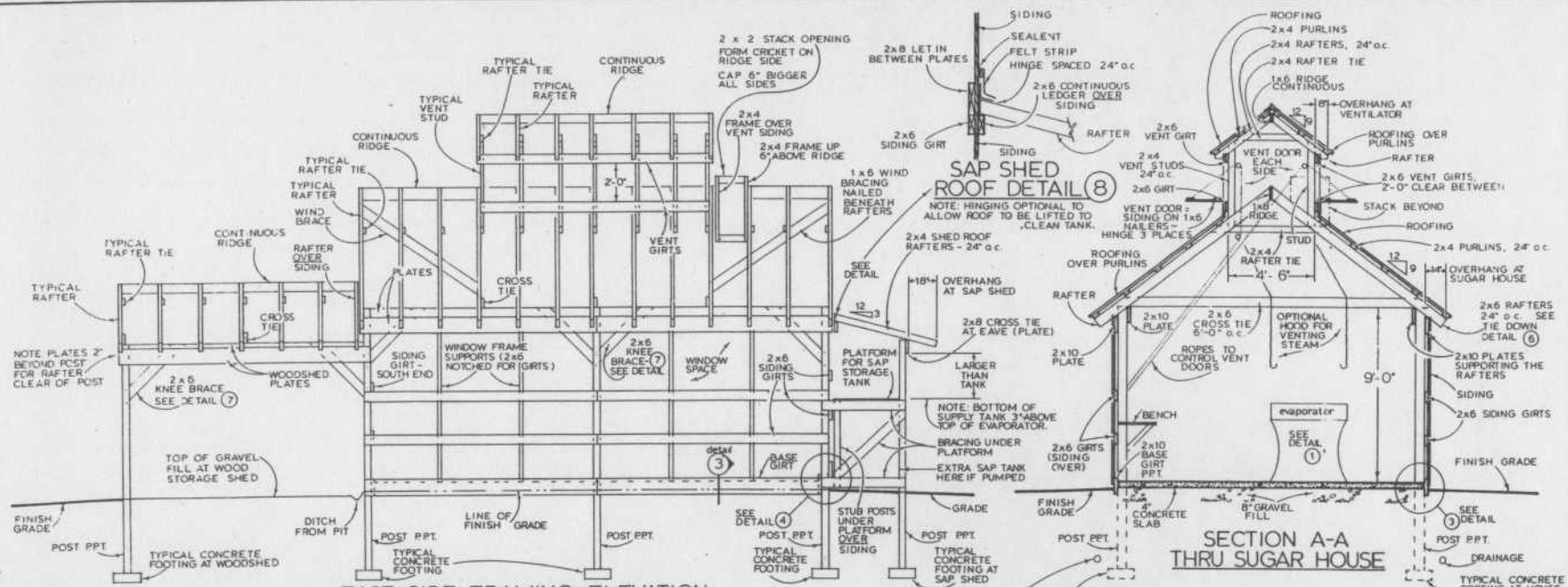

**EAST SIDE FRAMING ELEVATION**  
WEST SIDE SIMILAR, OPPOSITE HAND

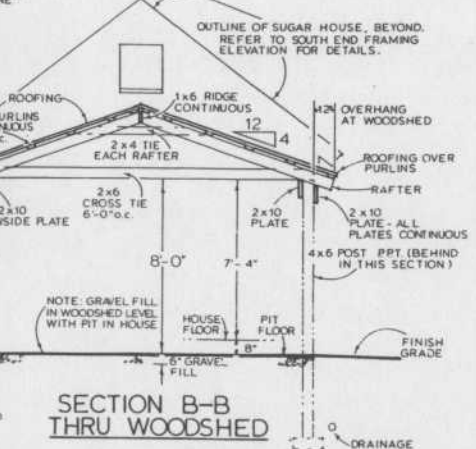
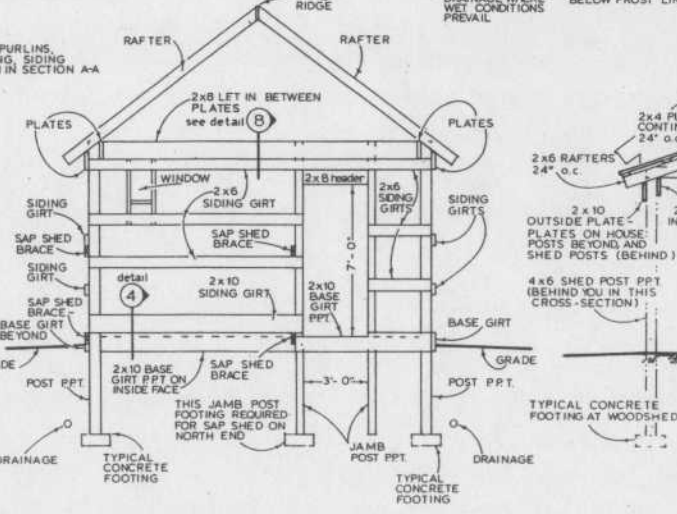
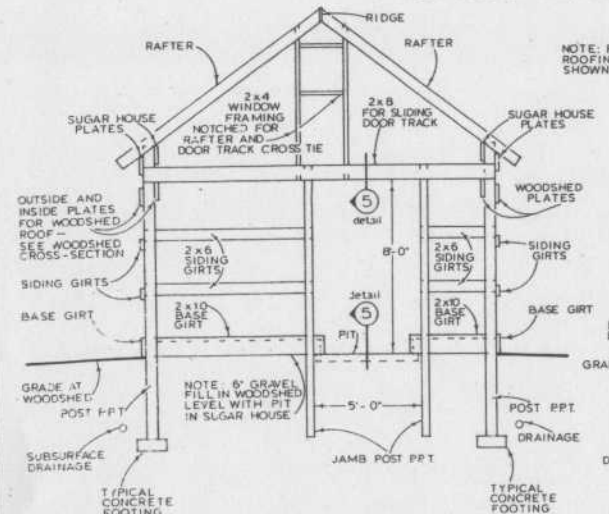

VERMONT EXTENSION SERVICE		
COLLEGE OF AGRICULTURE		
VOTEC DEPARTMENT		
UNIVERSITY OF VERMONT		
<b>16x24 SUGAR HOUSE</b>		
USDA	VT EX 200	SHEET 2 OF 3
DRAWN BY J.B.C.	CHECKED BY G. D. W.	DATE 30 JUNE 77





LIST OF MATERIALS: 16 x 24 Sugarhouse (Plan #VT. EX. 200)

24

SUGARHOUSE, POST CONSTRUCTION

(sugarhouse, frame construction, ventilators, sap and wood storage listed separately)

Item	Length (ft)	Quantity	
Gravel fill	--	10 yds	
Concrete (not including arch foundation)	--	5 yds	
4x6 PPT main posts	14	6	
4x4 PPT door jamb posts	14	5	
2x10 PPT base girts	12	4	
2x10 Plates	12'-2"	8	
2x10 Siding girts	10	1	
2x8 for sliding door tracks	16	1	
2x8 let in between plates (N-end)	16	1	
2x8 door headers	4	2	
2x6 Rafters	12	26	
2x6 Cross ties	16	3	
2x6 Siding girts on building ends	12	8	
2x6 Window framing	9	8	
2x6 Knee bracing	4	8	
2x6 Rafters ties to plates	1½	20	
2x4 Purlins	300	--	
2x4 Rafter ties	6	13	
2x4 Bearing blocks	2 or 3 ft	12	
2x4 Miscellaneous and end framing	30	--	
2x4 Framing for stack opening	20	--	
1x6 Wind bracing	8	4	
1x8 Ridge board	12'-2"	2	
Totals	2x10 (untreated)	120	200 FBM
	2x8	40	53
	2x6	700	700
	2x4	470	313
Total dimension lumber			1300 FBM
Roofing area including ventilators			580 sq ft
Siding area less doors and windows			800 sq ft
Doors, hinged	3' x 7'	2	
Doors, sliding	6½' x 8'	1	
Windows, side	3' x 3'	4	
Window, gable	2' x 2'	1	
Window, sap storage	1' x 1'	1	

SUGARHOUSE, FRAME CONSTRUCTION

(ventilators, sap and wood storage listed separately)

Item	Length (ft)	Quantity
Gravel fill		10 yds
Concrete (not including arch foundation)		10 yds
2x6 Rafters	12	26
2x6 Cross ties	16	3
2x6 Studs, side	8	30*
2x6 Plates	12	8
2x6 Sills, side	12	8
Sills, end	10	4
2x6 End framing	170	-
2x6 Sliding door track	16	1
2x4 Purlins	300	-
2x4 Rafter ties	6	13
2x4 Framing for stack opening	20	-
1x8 Ridge board	12'-2"	2
1x6 Wind bracing	8	4
1x6 Corner bracing	8	8
Totals 2x6	1100	1100 FBM
2x4	400	267 FBM
Total dimension lumber		1400 FBM

--Siding and roofing same as for post construction.

\*Double studs at corners, no allowance made for windows.

WOOD STORAGE (one bay)

Item	Length (ft)	Quantity
Gravel fill	--	4 yds
4x6 PPT posts	12	2
2x10 Plates	13	4
2x6 Rafters	10	14*
2x6 Cross ties	16	2
2x6 Knee bracing	4	6
2x6 Rafter ties to plate	1½	10
2x4 Purlins	12'-4"	12
2x4 Rafter ties	6	6
1x6 Ridge board	12'-4"	1
Totals 2x10	55	92 FBM
2x6	220	220 FBM
2x4	190	127
Total framing (untreated)		440 FBM
Roofing		240 sq. ft.

\*12 rafters for each additional bay.

SAP STORAGE

Item	Length (ft)	Quantity
4x4 PPT Platform posts	5	4
4x4 PPT Corner posts to roof	12	2
2x8 Plate	10	1
2x6 Ledger	10	1
2x6 Platform bracing	5	15
2x4 Purlins	10	4
2x4 Rafters	6	6
<b>Total framing (untreated)</b>		<b>150 FBM</b>
Platform floor		40 sq ft
Roofing		60 sq ft

CUPOLA VENTILATOR

Item	Length (ft)	Quantity
2x6 Ventilator girts	12'-2"	2
	12	2
2x4 Rafters	4	14
2x4 Rafters ties	3	7
2x4 Purlins	80 ft	-
2x4 Studs	5	14
1x6 Ridge board	12'-2"	1
1x6 Door nailers	12	4
<b>Total framing</b>		<b>225 FBM</b>
Siding, ventilators, doors, and ends		30 sq ft
--Roofing, included in sugar house roof estimate		

ALTERNATE ROOF VENTILATORS

Item	Length (ft)	Quantity
2x7 Ledger	12	2
2x4 Levers	6 to 8 ft	4
1x4 Nailers	150 ft	-
<b>Total framing</b>		<b>100 FBM</b>
--Roofing, included in sugar house roof estimate		

Notes

Lengths are generally given to allow a little extra for cutting to exact length.

Cost estimates can be filled in by builder.

Totals include approximately 5 percent extra for waste in construction.

FBM - Board feet measure.

Roofing area does not allow for any overlap of metal sheets. Allow about 20 percent extra for wood siding as there will be some cut to waste.

Use 4½ inch (30 d) ring shank nails to fasten plates, girts, and bracing to poles.

Use 12 d (3¼ inch) nails for all dressed framing or 16 d (3½ inch) nails for rough framing lumber.

Figure approximately 8 pounds of nails per 1000 board feet for framing.

Concrete: 3000 psi.

Lumber: Purchased-No. 1 construction grade, dressed; or homegrown hemlock, spruce or pine rough or smooth, dried, and carefully selected for uniformity and free of defects.

Treated lumber: All posts and base girts shall be pressure preservative treated (PPT).